

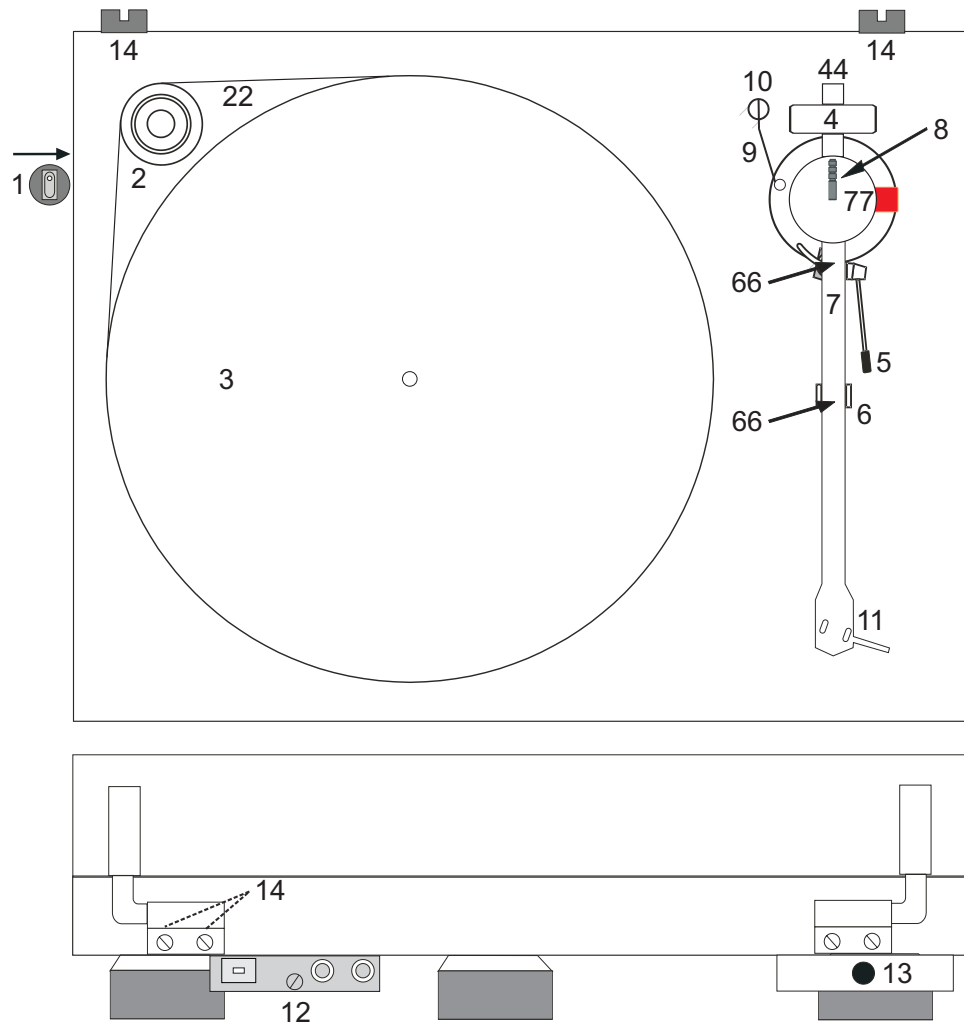

INSTRUCTIONS FOR USE  
Pro-Ject Essential/Phono USB



## Controls, features and connections

- 1 Power switch
- 2/22 Stepped drive pulley and drive belt \*
- 3 Platter with felt mat \*
- 4/44 Tonearm counterweight \* and counterweight support rod
- 5 Tonearm lift lever
- 6/66 Tonearm rest and removable transport locks
- 7/77 Tonearm tube with tonearm bearing housing and orange coloured transport lock
- 8 Anti-skating weight adjustment scale
- 9 Anti-skating weight support hoop
- 10 Anti-skating weight with wire \*
- 11 Headshell with finger lift and fitted Ortofon 2M Blue cartridge
- 12 Phono output sockets, earth connection and USB-out
- 13 Power supply socket
- 14 Hinge with hinge fasteners  
Signal output and USB-cable  
Power supply (not shown) \*  
Stylus pressure gauge - white plastic instrument with mN scale (not shown) \*  
Two hexagonal keys (not shown) \*

# Pro-Ject Essential/Phono USB

Dear music lover,

thank you for purchasing a PRO-JECT AUDIO record player.

In order to achieve maximum performance and reliability with this record player you should study these instructions for use carefully.



*Warning of a hazard for the user, the unit or possible misuse.*



*Important notice.*

The record player is supplied with a factory fitted and adjusted cartridge.

\*\* The following instructions for adjusting the cartridge are provided in case the cartridge is replaced by a different model at a later date.

During assembly and adjustment of the deck small parts could be lost if not carefully placed in a suitable receptacle. Before starting assembly make yourself acquainted with the parts listed above and correspondingly numbered in the technical drawings above. Separately packed items are marked with an asterisk \*.

## Set-up

Make sure the surface you wish to use the turntable on is level (use a spirit level) before placing the turntable on it.

Fit the drive belt (22) around the platter (3) and the smaller diameter part of the motor pulley (2). Avoid getting sweat or grease on the belt as these will deteriorate the performance and reduce the belt's lifespan. Use absorbent kitchen paper to remove any oil or grease from the outer edge of the platter and the belt.

Fit the felt mat over the spindle of the platter (3). Remove both transport locks (66) from the tonearm tube.

To remove the transport lock for the arm bearing, lift up the tonearm by the tonearm bearing housing and pull out the red coloured transport lock towards the right hand side. Put the tonearm back into place.



*Take special care not to strain or damage the delicate 4-colour wire!*

Store the transport locks in the original packaging so they are available for any future transportation.

## Cartridge downforce adjustment

The counterweight (4) supplied is suitable for cartridges weighing between 4 - 9g.

Place counterweight (4) halfway along the counterweight support rod (44) at rear of arm, being sure to have the securing screw uppermost.

Remove the felt matt. With the power off, and the platter static, place the stylus pressure gauge onto the platter. To set the recommended 17,5mN downforce (1mN = 0,1g / 0,1 Pond), place the tip of the stylus exactly in-between the two points marked 15mN and 20mN.

If the stylus gauge becomes level, then the correct pressure has been achieved. However if there is insufficient or excessive pressure the gauge will either not move or tilt down.

To adjust the amount of pressure, carefully move the counterweight (4) along the support rod (44), until the stylus pressure is sufficient to raise the pressure gauge to the level position. Moving the counterweight (4) towards the cartridge will reduce pressure and away will increase pressure.

Finally secure the counterweight (4) using hexagonal key provided.



*Please note: It is advised to remove stylus tip from gauge whilst making adjustments to avoid damage to stylus.*

## Anti-skating force adjustment

Hang the loop of the thread of the anti-skating weight in the groove of the anti-skating stub (8) corresponding to the downforce applied to your cartridge and feed the thread through the loop of the wire support (9).

\*\* The anti-skating force must be adjusted corresponding to the downforce as follows:

<u>Downforce</u>	<u>Groove in the stub (8)</u>
10 - 14mN	1 <sup>st</sup> from bearing rings
15 - 19mN	2 <sup>nd</sup> " " "
20mN and bigger	3 <sup>rd</sup> " " "

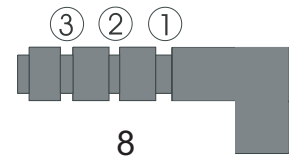

## Connection to the amplifier

The record player has gold plated female RCA phono sockets (14) so you can substitute the interconnect cables supplied with those of your choice for connection to the amplifier if you wish. Your dealer can advise you on alternative cables. Use a line input (such as AUX, CD, Tuner, Tape or Video) on your amplifier.



*Due to the built in phono pre-amplifier, a phono input (sometimes labelled gram, disc or RIAA) is not suitable. **Connecting to a Computer, see page 5.***

Take care to connect the left and right channels correctly. The right channel is usually marked red, the left channel black or white. Check the manual supplied with your amplifier for relevant information. The earthing wire of the tonearm lead should be connected to the earth terminal on your amplifier (if provided).

The 3,5 mm connector (supplied) can be used to connect your Pro-Ject Debut III/Phono USB to any line level/auxiliary input (Computer, Midi System, Mixer etc.).

Connect the socket end to the phono plugs at the end of the audio trailing lead from your turntable and insert the 3,5 mm plug into the relevant socket on your audio component.

## Mains power connection

The turntable is supplied with a power supply suitable for your country's mains supply. Check the label before connecting to ensure compliance with the mains rating in your house.

Connect the low voltage plug from the power supply to the socket (8) on the rear of the record player before connecting the power supply to the mains.

## Fitting the lid

Fit the lid (dust cover 10) carefully over the hinge prongs and adjust the screws (12) until the lid stays open where you want it to without being too stiff to open or close.

## Switching on and off

Pressing the power switch (1) alternately starts or stops the motor.

## Changing replay speed

Put the belt (22) over the larger diameter part of the motor pulley (2). To revert to 33 1/3 r.p.m. repeat the proceedings using the smaller step on the pulley.



*When the Pro-Ject Speed Box or the Speed Box SE are used speed change between 33 and 45 r.p.m. is electronic. There is no need to move the belt manually.*

*For detailed product information please refer to the Pro-Ject web site [www.project-audio.com](http://www.project-audio.com).*

## Connecting to a Computer (e. g. with Microsoft™ Windows™ XP)

1. Connect the USB-output of the Essential Premium/Phono USB to a free USB-socket on your computer and turn it on/make sure it is powered on.



Please note: Connection should be made to an USB-socket of your computer directly. Connecting to USB-hubs or switches can cause problems.

2. The “new hardware found assistant” will automatically detect the unit and announces it as a “USB audio codec”.
3. open the System menu via “Start” (Windows key)  
→ Settings  
→ Control Panel  
→ Sound and Audio Devices

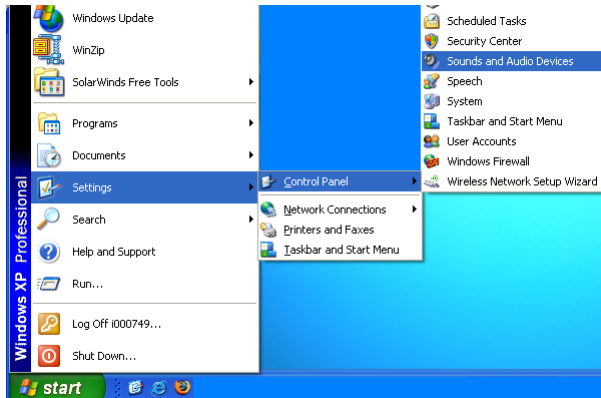

4. In the control panel open the “Sound and audio” menu.

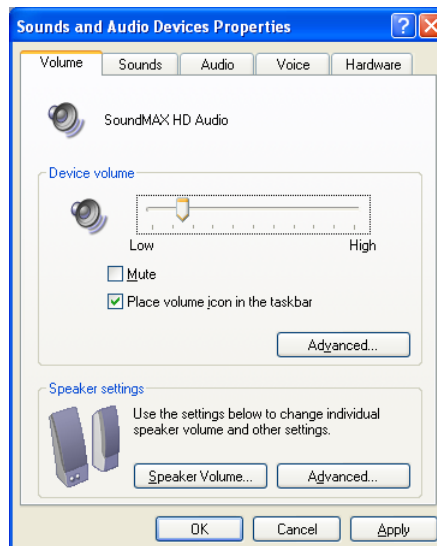

5. In the Sounds and Audio panel select the Audio tab. In the Replay section select your sound card from the pull-down lists (usually preselected).

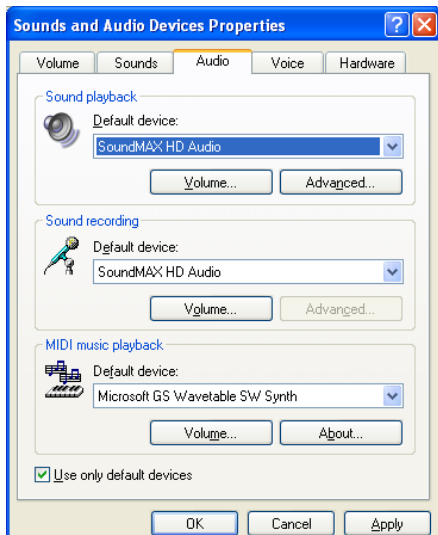

6. Select the USB Audio CODEC from the pull down list in the Recording section. Make sure your sound card is selected for Replay.

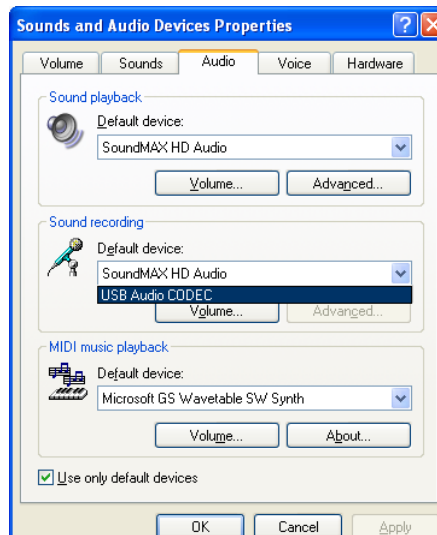

7. Confirm your selections by clicking the OK button.
8. Close the control panel windows and start your recording programme.

In case you do not have a recording programme installed on your computer, you may download one free from the Internet. Recording programmes may be found by searching Google or Altavista.



Please be aware that downloads from the Internet are made entirely at your own risk. Under no circumstances can we carry responsibility or provide support for software products sourced from the internet or for any damage or problems arising from the use thereof. All downloads should be checked with an up-to-date anti-virus programme. License fees may be applicable.

## Connecting to a Computer (e. g. with Microsoft™ Windows 7™)

1. Connect the USB-output of the Essential Premium/Phono USB to a free USB-socket on your computer and turn it on/make sure it is powered on.



*Please note: Connection should be made to an USB-socket of your computer directly. Connecting to USB-hubs or switches can cause problems.*

2. Open the "Recording" panel. → **Start** → **Control Panel** → **Hardware and Sound** → **Sound** → **Recording**  
In the "Recording" panel "**USB Audio Device**" (announced as "Microphone") should be selected (usually preselected).

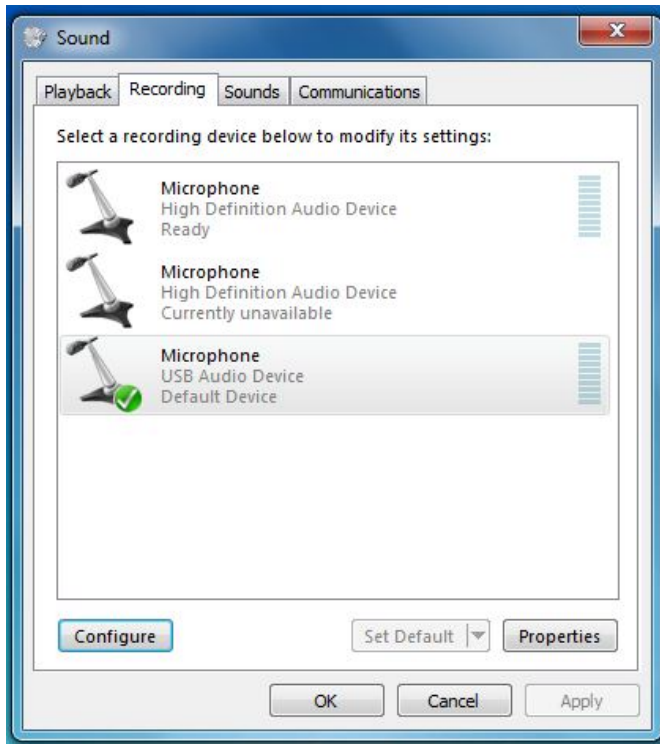

3. Click the OK button and close the control panel windows.
4. Close the control panel windows and start your recording programme.

In case you do not have a recording programme installed on your computer, you may download one free from the Internet. Recording programmes may be found by searching Google or Altavista.



*Please be aware that downloads from the Internet are made entirely at your own risk. Under no circumstances can we carry responsibility or provide support for software products sourced from the internet or for any damage or problems arising from the use thereof. All downloads should be checked with an up-to-date anti-virus programme. License fees may be applicable.*

## Connecting to a Computer (Mac OS™)

1. Connect the USB-output of the Essential Premium/Phono USB to a free USB-socket on your computer and turn it on/make sure it is powered on.



*Please note: Connection should be made to an USB-socket of your computer directly. Connecting to USB-hubs or switches can cause problems.*

2. Open the “System Preferences” panel and select “**Sound**”.



3. In the “Input” panel “**USB Audio CODEC**” should be selected (usually preselected).

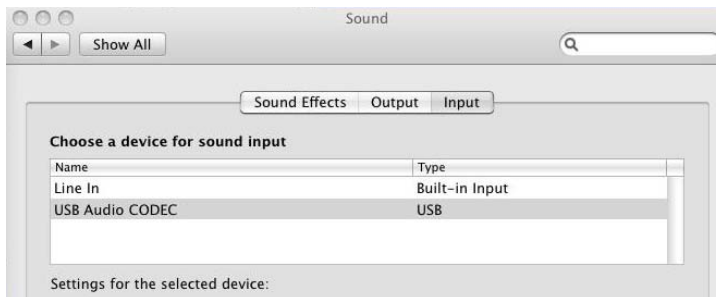

4. Close the control panel windows and start your recording programme.

In case you do not have a recording programme installed on your computer, you may download one free from the Internet. Recording programmes may be found by searching Google or Altavista.



*Please be aware that downloads from the Internet are made entirely at your own risk. Under no circumstances can we carry responsibility or provide support for software products sourced from the internet or for any damage or problems arising from the use thereof. All downloads should be checked with an up-to-date anti-virus programme. License fees may be applicable.*

## Maintenance and cleaning

Your record player requires little or no regular maintenance. Remove dust with a slightly moistened antistatic cloth. Never use a dry cloth because this will create static electricity which attract more dust! Antistatic cleaning fluids are available at specialist stores but must be applied sparingly to avoid damage to rubber parts. It is recommended to fit the needle cover before cleaning or maintenance is carried out to avoid damage. If the player is not used over a long period of time the drive belt can be removed to prevent unequal stretching.



*Always disconnect the record player from the mains power supply as a precaution before maintenance!*

## Fitting and connecting the cartridge

\*\* All cartridges with half inch mounting holes can be fitted. Leaving the needle's protection cover on, fit the cartridge to the headshell (11) using the screws supplied with the cartridge by passing one screw through each slot in the headshell (11). Do not tighten the nuts yet.

Connect the tonearm wires to the cartridge pins as follows:

white	left channel positive (L+)
red	right channel pos. (R+)
green	right channel return (R -)
blue	left channel return (L -)

The full sound quality of the record player can only be achieved if the cartridge is correctly adjusted. Particular tools like the Pro-Ject alignment tool "Align it" are required to accomplish this job properly.

If you are not well acquainted with the adjustment of cartridges you are advised to call upon the willing help of your Pro-Ject dealer to accomplish this task for you.



*Please note: adjusting a cartridge and tonearm calls for the greatest care in order to avoid damaging the cartridge or tonearm bearings. Leave this work to your dealer if you are in any way unsure of the necessary steps and precautions to be taken.*

## Useful tips

The record player should be positioned on a low-resonance surface such as wood or multiple layer ply board to avoid structural vibrations disturbing replay.

## Technical specifications Pro-Ject Essential/Phono USB

Nominal speeds	33,33/45,11 r.p.m.
Speed variance	±1,5%
Wow and flutter	±0,25%
Signal to noise	-65dB
Downforce range	15-30mN
Effective tonearm length	8,6" (218,5mm)
Overhang	18,5mm
Power consumption	2W
Outboard power supply	16V/500mA AC, suitable for your country's mains supply
Dimensions (W x H x D)	415 x 112 x 335mm
Weight	3,9kg

## Technical specifications MM-Cartridge Ortofon 2M Blue

Frequency range	20-25.000Hz
Channel separation	25dB/1kHz
Output voltage	5mV
Recommended load resistance	47kohms/amplifier connection – MM-input
Compliance/stylus type	20µm/mN – elliptical, nude
Recommended tracking force	18mN
Weight	7,2g



## Technical specifications Moving magnet phono pre-amplifier

Gain	32dB
Output voltage typically	160mV/1kHz at 4mV/1kHz input
Input impedance	47kohms/100pF
Noise floor	-88dB
RIAA-equalisation curve accuracy	20Hz-20kHz / max. 0,5dB
USB output:	digital serial data protocol USB 1.1
Operating systems:	Windows® and MacOS®

## Potential incorrect use and fault conditions

PRO-JECT turntables are manufactured to the highest standards and undergo strict quality controls before leaving the factory. Faults that may possibly occur are not necessarily due to material or production faults but can sometimes be caused by incorrect use or unfortunate circumstances. Therefore the following list of common fault symptoms is included.

### The platter doesn't turn although the unit is switched on:

- The unit is not connected to the mains power supply.
- No mains at the socket.
- Drive belt is not fitted or has slipped off.

### No signal through one or other channel or both channels:

- No signal contact from the cartridge to the internal tonearm wiring or from that to the arm lead or from that to the phono box or between that and the amplifier. This could be due to a faulty plug, broken wire or solder joint or simply loose plug/socket connection.
- Phono input not selected at amplifier.
- Amplifier not switched on.
- Amplifier or speakers defective or muted.
- No connection to the loudspeakers.

### Strong hum on phono input:

- No earth connection from cartridge or arm or arm cable to amplifier, or earth loop.

### Distorted or inconsistent sound from one or both channels:

- Record player is connected to wrong input of amplifier, or MM/MC switch incorrectly set.
- Needle or cantilever damaged.
- Wrong r.p.m., drive belt overstretched or dirty, platter bearing without oil, dirty or damaged.

## Service

Should you encounter a problem which you are not able to alleviate or identify despite the above information, please contact your dealer for further advice. Only when the problem cannot be resolved there should the unit be sent to the responsible distributor in your country.

Guarantee repairs will only be effected if the unit is returned correctly packaged. For this reason we recommend keeping the original packaging.

Never return a record player without making sure that it is safely disassembled and correctly packaged in the original packaging according to the diagrams on the last page of this user guide.

Fit the cartridge protection cap. Insert the transport locks for the tonearm tube (66) and the red coloured transport lock (77) for the tonearm bearing housing, prior to carefully packaging the record player.

## Warranty



*The manufacturer accepts no responsibility for damage caused by not adhering to these instructions for use and/or by transportation without the original packaging. Modification or change to any part of the product by unauthorized persons release the manufacturer from any liability over and above the lawful rights of the customer.*

PRO-JECT is a Registered Trademark of H. Lichtenegger. The information was correct at the time of going to press. The manufacturer reserves the right to make  
This guide was produced by: Audio Trade GmbH

